



INSIDE316L



NON SOLO UN'AZIENDA, UN'IMPRESA DI FAMIGLIA



Angiolino Seneci

“Sono nato e cresciuto a Lumezzane, un posto in cui si viveva a pane e metallo. Ho iniziato a lavorare al tornio manuale, ancora prima di imparare a giocare a pallone, e grazie alla pazienza di mio nonno ho scoperto la passione per la lavorazione artigianale, conoscendo a fondo tutti i segreti dell'acciaio inox. Ho condiviso con la mia famiglia tutti gli aspetti della produzione artigianale, da sempre parte della mia cultura, coinvolgendo mia moglie Tania ed i miei figli Francesca e Stefano e sono stato uno dei primi ad utilizzare per tutti i miei prodotti unicamente l'acciaio inox 316. Oggi produciamo docce, soffioni e miscelatori per esterno ed interno, passo dopo passo, con accurato montaggio a mano e controllando ogni passaggio, senza perdere il legame con il passato, ma guardando sempre al futuro”

NOT JUST A COMPANY, A FAMILY BUSINESS

“I was born and raised in Lumezzane, a place where people lived with 'bread and metal'. I started working on the manual lathe, even before learning to play football, and thanks to my grandfather's patience I discovered a passion for craftsmanship, knowing all the secrets of stainless steel in depth. I shared with my family all aspects of artisanal production, which has always been part of my culture, involving my wife Tania, my daughter Francesca and my son Stefano and I was one of the first to use only 316 stainless steel for all my products. Today we produce showers, shower heads and mixers for indoor and outdoor use, step by step, with careful assembly by hand and checking every step, without losing the link with the past, but always looking to the future.”

INSIDE316L

Inside316L rappresenta un concept che inaugura un capitolo nella storia di Ama. Con questo progetto, Ama consolida il proprio percorso nel mondo dell'interior, dialogando con il linguaggio dell'architettura. Le nuove proposte, realizzate rigorosamente in acciaio inox 316L, uniscono design, prestazioni tecniche e durabilità, offrendo soluzioni pensate per contesti progettuali di alto livello.

Inside316L introduces a concept that marks a new chapter in Ama's history. With this project, Ama strengthens its path in the world of interior design, engaging in a dialogue with the language of architecture. The new proposals, crafted exclusively in 316L stainless steel, combine design, technical performance, and long-lasting durability, offering solutions conceived for high-end architectural environments.



L'ARCHITETTURA DELL'ACQUA

THE ARCHITECTURE OF WATER

Il quality concept di ama ridefinisce l'ambiente bagno come un vero e proprio spazio architettonico, dove ogni rubinetto, colonna doccia o soffione cromoterapico diventa protagonista di un'esperienza sensoriale e stilistica unica. L'acqua non è più solo elemento funzionale, ma materia da modellare, da vivere, da raccontare. Ogni linea e ogni dettaglio sono studiati per elevare l'ambiente contemporaneo a un luogo con forte identità personale, dove vivere, condividere, immaginare e sognare non sono azioni occasionali, ma parte di un dialogo costante tra forma, design e funzionalità. Le collezioni ama diventano così puro arredamento del bagno, componendo spazi coerenti e raffinati che combinano linearità, finiture materiche e abbinamenti cromatici decisi. Una nuova chiave di lettura del bagno contemporaneo, dove il design diventa architettura dell'acqua: intensa, ricercata e assolutamente moderna.

Ama's quality concept redefines the bathroom as a true architectural space, where every faucet, shower column, or chromotherapy showerhead becomes the protagonist of a unique sensorial and aesthetic experience. Water is no longer a purely functional element, but a material to shape, to live, and to narrate. Every line and every detail are designed to elevate the contemporary environment into a place with a strong personal identity, where living, sharing, imagining, and dreaming are not occasional actions, but part of a constant dialogue between form, design, and functionality. Ama collections thus become true bathroom furnishings, creating coherent and refined spaces that combine clean lines, textured finishes, and bold color palettes. A new interpretation of the contemporary bathroom, where design becomes the architecture of water: intense, sophisticated, and unmistakably modern.

UNA STORIA, UN TERRITORIO, UNA PASSIONE

Da oltre 30 anni, l'esperienza che si tramanda da tre generazioni di attività in ambito meccanico e della rubinetteria ha permesso di dare il via ad un progetto di azienda e di vita, grazie all'intuizione di utilizzare unicamente un materiale nobile, come l'acciaio inox 316, per i complementi d'arredo esterni e per la gamma di rubinetteria. La produzione Ama, 100% Made in Italy, ha sede a Lumezzane (Brescia), un distretto industriale di eccellenza mondiale nella lavorazione dei metalli. L'attenta scelta delle materie prime e il rigoroso controllo di ciascuna fase del processo produttivo assicurano un prodotto affidabile, dalle grandi prestazioni. Con l'impegno costante, dall'incontro tra artigianalità e design, nascono i prodotti di Ama, che giorno dopo giorno racconta una storia di passione di un'intera famiglia.

DA SEMPRE, ARTIGIANI DELL'ACCIAIO INOX

L'acciaio inossidabile è garanzia di resistenza e bellezza nel tempo. Ama ha da sempre scelto di utilizzare per la sua produzione soltanto acciaio inox 316L; questo materiale ha caratteristiche di robustezza maggiori, è eterno e totalmente riciclabile. La caratteristica durezza dell'acciaio inossidabile AISI 316L garantisce una lunga durata dei prodotti Ama nel tempo, resistente a graffi e scalfitture, agenti esterni e salsedine. La cura nella scelta di materie prime d'eccellenza permette di non aggiungere trasformazioni chimiche al processo produttivo. Il risultato è una gamma di prodotti fortemente igienica, atossica e totalmente riciclabile.

L'ACQUA, UN BENE PREZIOSO

Nelle collezioni Ama l'erogazione dell'acqua è regolata da aeratori e limitatori, nonché da cartucce che riducono i passaggi e la portata del flusso. Queste soluzioni permettono di ottimizzare i consumi senza rinunciare al comfort, assicurando un getto equilibrato e piacevole. Un approccio progettuale consapevole che contribuisce a ridurre gli sprechi e a valorizzare ogni utilizzo. Tecnologia e sostenibilità si integrano così in un sistema efficiente, pensato per l'abitare contemporaneo.

A HISTORY, A REGION, A PASSION

For over 30 years, the experience passed down from three generations of mechanical and tap manufacturing has allowed to launch a business and life project, thanks to the intuition of using only a noble material, such as 316 stainless steel, for outdoor shower solutions and for the tapware range. Ama's production, 100% Made in Italy, is based in Lumezzane (Brescia), an industrial district of global excellence in metalworking. The careful selection of raw materials and the rigorous control of every stage of the production process ensure reliable products with outstanding performance. Through constant commitment and the synergy between craftsmanship and design, Ama products take shape—day after day telling the story of a family driven by passion.

CRAFTSMEN OF STAINLESS STEEL, FROM DAY ONE

Stainless steel is a guarantee of longlasting strength and beauty. Ama has always chosen to use exclusively 316L stainless steel for its production; this noble material offers superior robustness, is eternal, and is fully recyclable. The inherent hardness of AISI 316L stainless steel ensures exceptional durability for Ama products, making them resistant to scratches, abrasions, external agents, and even marine corrosion. The meticulous selection of premium raw materials allows the production process to remain free from chemical treatments. The result is a range of products that are highly hygienic, nontoxic, and completely recyclable.

WATER, A PRECIOUS RESOURCE

In Ama collections, water flow is managed through aerators, flow limiters, and cartridges designed to reduce internal passages and overall consumption. These solutions optimize water use without compromising comfort, ensuring a balanced and pleasant jet. It is a conscious design approach that helps reduce waste while enhancing every interaction with water. Technology and sustainability come together in an efficient system conceived for contemporary living.





PROGETTI SU MISURA

BESPOKE PROJECT

La scelta aziendale di una produzione artigianale unita alla conoscenza dei processi produttivi, sono elementi essenziali per la realizzazione, in piccoli o grandi lotti, di varianti di prodotti standard o articoli su misura partendo dallo studio e approvazione della richiesta. Un team di tecnici dedicato e preparato è in grado di analizzare ogni specifica richiesta e di proporre le soluzioni migliori per soddisfare le necessità del cliente, il quale potrà definire dimensioni, finiture e utilizzo per ottenere il prodotto richiesto.

The company's choice to maintain an artisanal approach, combined with indepth knowledge of production processes, is essential for creating both small and large batches of customized products—whether variations of standard items or fully bespoke solutions developed from the initial brief through to final approval. A dedicated and highly skilled technical team is able to analyze every specific request and propose the most suitable solutions to meet the client's needs. Dimensions, finishes, and intended use can all be defined to achieve the desired product.

L'ESSENZA DELLE FINITURE AMA

THE ESSENCE OF **AMA FINISHES**

STANDARD



LUCIDA
POLISH



SATINATA
BRUSHED

VERNICIATURE \ PAINTING



DEEP MATTE BLACK

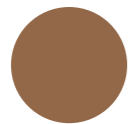

INTENSE BRONZE



DESERT GOLD



AGED BRASS



BROWN STONE



PURE CLOUD

PVD



BLACK DIAMOND



GRAPHITE



SUNSET COPPER

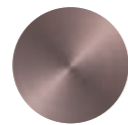

MOON STONE



BRUSHED BRASS



GOLD TOUCH





INTERIOR SERIES

RUBINETTERIA \ TAPS

RHEA	15
SHIVA	23
LINK <small>DESIGN BY CLAUDIO PAPA</small>	33
STELLA <small>DESIGN BY STEFANO PASOTTI</small>	45
ATLAS MINIMAL	57

COLONNE DOCCIA \ SHOWER COLUMNS

DORIDE	65
--------	----

SOFFIONI E CROMOTERAPIA \ SHOWER HEADS AND CHROMOTHERAPY

URANO	69
SUNRING	75
PLUVIO	81
RAINYCLOUD <small>DESIGN BY SIMONE MICHELI</small>	87

ACCESSORI BAGNO \ BATHROOM ACCESSORIES

92

RHEA

RUBINETTERIA \ TAPS

Complete and versatile, designed to adapt to a variety of architectural settings.

COMPLETA, VERSATILE, IDEALE PER ADATTARSI
A DIVERSI CONTESTI ARCHITETTONICI. \





RH044



RHE-PE-TD2DB-005



RH01P25

LAVABO
Washbasin

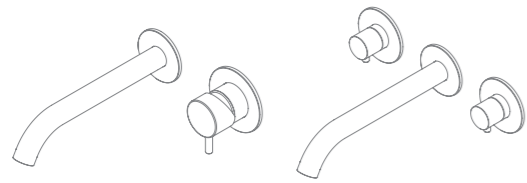

RHE-PE-BAC-002B RHE-PE-MB-002B

LAVABO
Washbasin

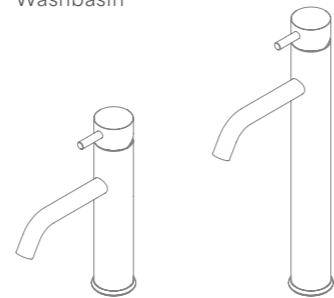

RH029 RH044

BIDET
Bidet



RH020

DOCCIA - TERMOSTATICO
Shower - thermostatic

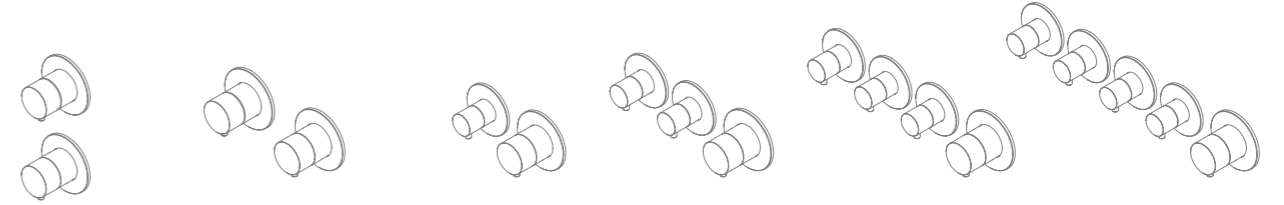

RHE-PE-TD2V-002 2-way diverter RHE-PE-TD2-004 2-way diverter RHE-PE-TAC-001A 1 stop valve RHE-PE-TAC-002B 2 stop valves RHE-PE-TAC-003C 3 stop valves RHE-PE-TAC-004D 4 stop valves

DOCCIA - MIXER
Shower - mixer

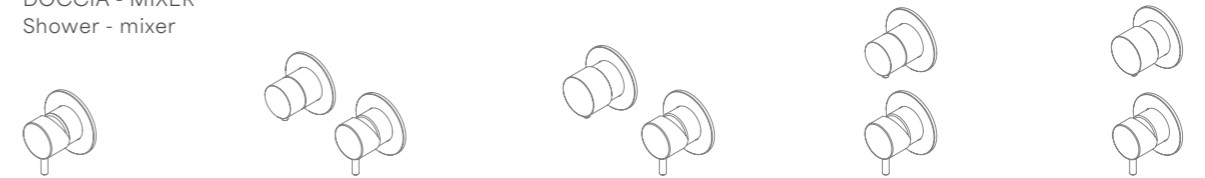

RHE-PE-M-001 RHE-PE-MD2-008 2-way diverter RHE-PE-MD3-009 3-way diverter RHE-PE-MD2V-004 2-way diverter RHE-PE-MD3V-006 3-way diverter

DOCCIA
Shower

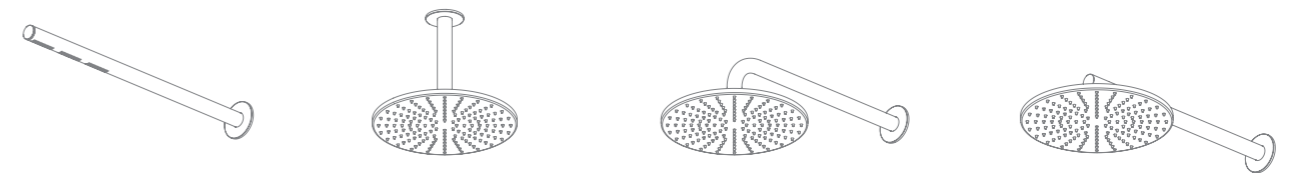

RH01P RH03S25 RH02C25 RH01P25

DOCCIA
Shower

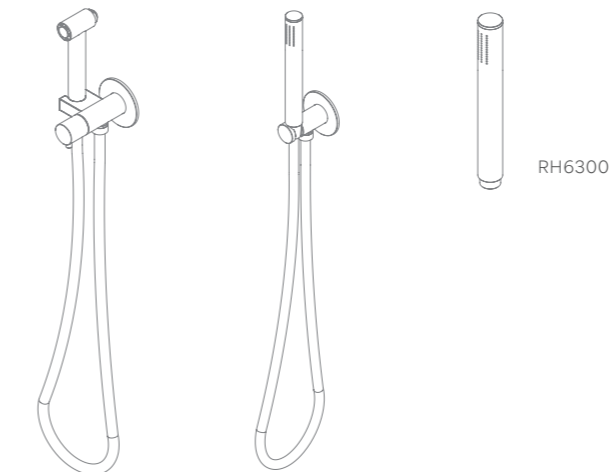

RH4400 RHE6350 RH6300

VASCA
Bathtub

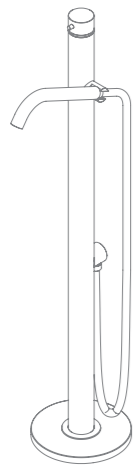

RH17500

VASCA - TERMOSTATICO
Bathtub - thermostatic

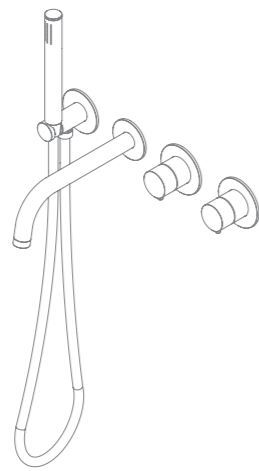

RHE-PE-TD2DB-005 2-way diverter

VASCA - MIXER
Bathtub - mixer

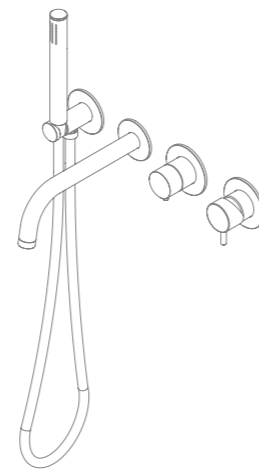

RHE-PE-MD2DB-002B 2-way diverter

DOCCIA - MIXER
Shower - mixer

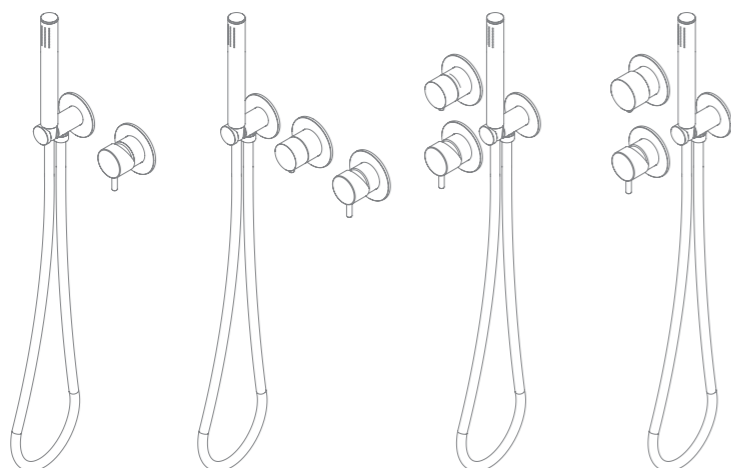

RHE-PE-MD-002 RHE-PE-MD2D-003 2-way diverter RHE-PE-MD2VD-005 2-way diverter RHE-PE-MD3VD-007 3-way diverter

DOCCIA - TERMOSTATICO
Shower - thermostatic

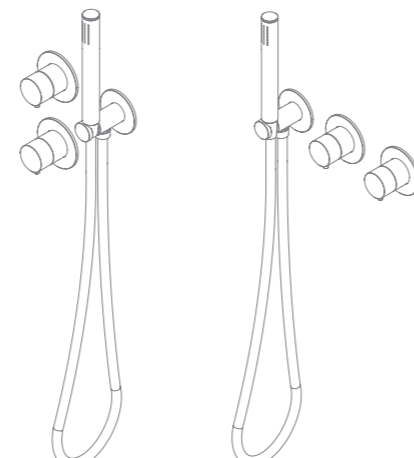

RHE-PE-TD2VD-003 2-way diverter RHE-PE-TD2D-001 2-way diverter

SHIVA

RUBINETTERIA \ TAPS

A solid design that transforms water into an immersive experience.

DESIGN SOLIDO PER OFFRIRE
UN GETTO MORBIDO E AVVOLGENTE. \



SHIVA

SHIVA

SHIVA

26



SH-PE-MB-002B



SHIVA



SHIVA



SH6800



SH-PE-TD2D-001

LAVABO
Washbasin

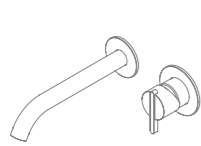

SH-PE-MB-002B



SH-PE-BAC-002B

VASCA - TERMOSTATICO
Bathtub - thermostatic

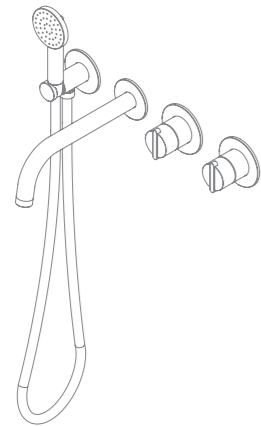

SH-PE-TD2DB-005
2-way diverter

VASCA - MIXER
Bathtub - mixer

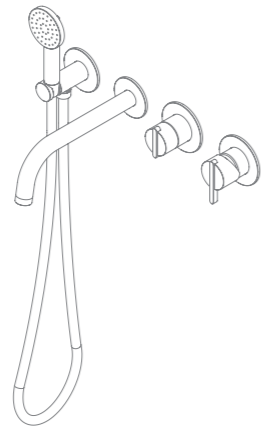

SH-PE-MD2DB-002B
2-way diverter

DOCCIA - TERMOSTATICO
Shower - thermostatic

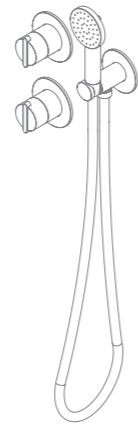

SH-PE-TD2VD-003
2-way diverter

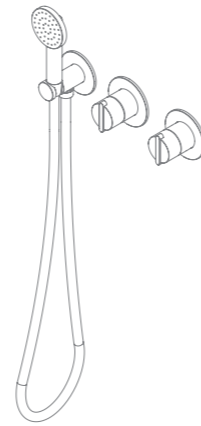

SH-PE-TD2D-001
2-way diverter

DOCCIA - MIXER
Shower - mixer

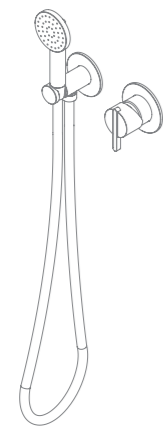

SH-PE-MD-002

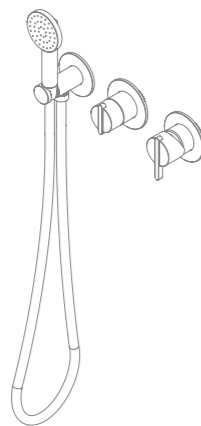

SH-PE-MD2D-003
2-way diverter

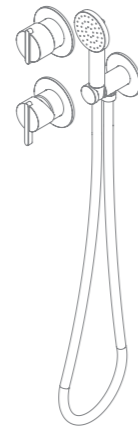

SH-PE-MD2VD-005
2-way diverter

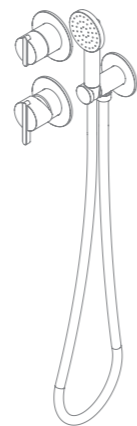

SH-PE-MD3VD-007
3-way diverter

DOCCIA - TERMOSTATICO
Shower - thermostatic



SH-PE-TD2V-002
2-way diverter



SH-PE-TD2-004
2-way diverter



SH-PE-TAC-001A
1 stop valves



SH-PE-TAC-002B
2 stop valves

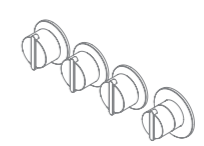

SH-PE-TAC-003C
3 stop valves

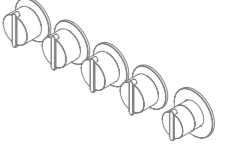

SH-PE-TAC-004D
4 stop valves

DOCCIA - MIXER
Shower - mixer



SH-PE-M-001

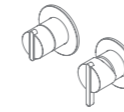

SH-PE-MD2-008
2-way diverter

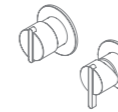

SH-PE-MD3-009
3-way diverter



SH-PE-MD2V-004
2-way diverter

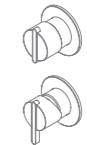

SH-PE-MD3V-006
3-way diverter

DOCCIA
Shower

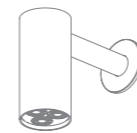

SH6800



SH6300

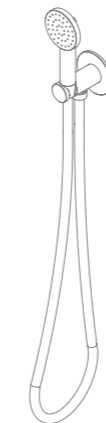

SH6350

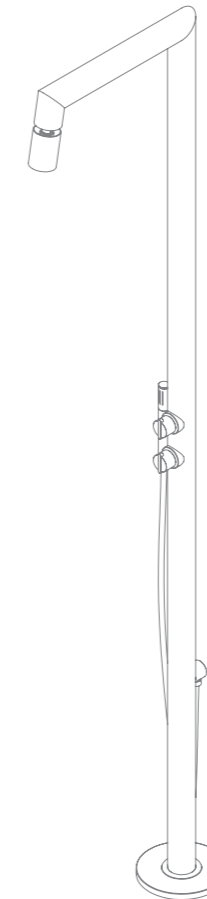

SH6700

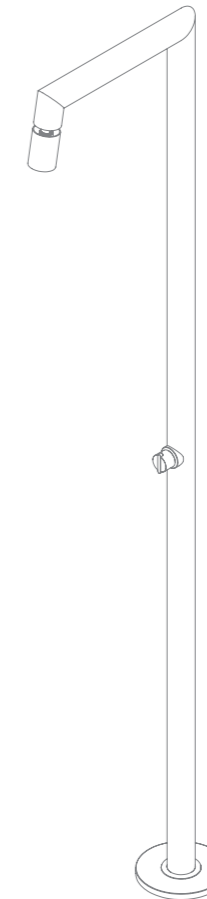

SH6500



LINK

RUBINETTERIA \ TAPS

DESIGN BY CLAUDIO PAPA

33

The quiet elegance of material, with steel transformed into expressive form.

LA CALMA NELLA MATERIA, L'ACCIAIO CHE DIVENTA GESTO. \



[LINK](#)

LINK



36

LN030IN

LINK

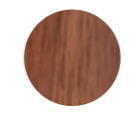

CANALETTO WALNUT



BLACK CORIAN



WHITE CORIAN

37

LINK



38

LINK



39

LN050



LN-PE-MD2V-004

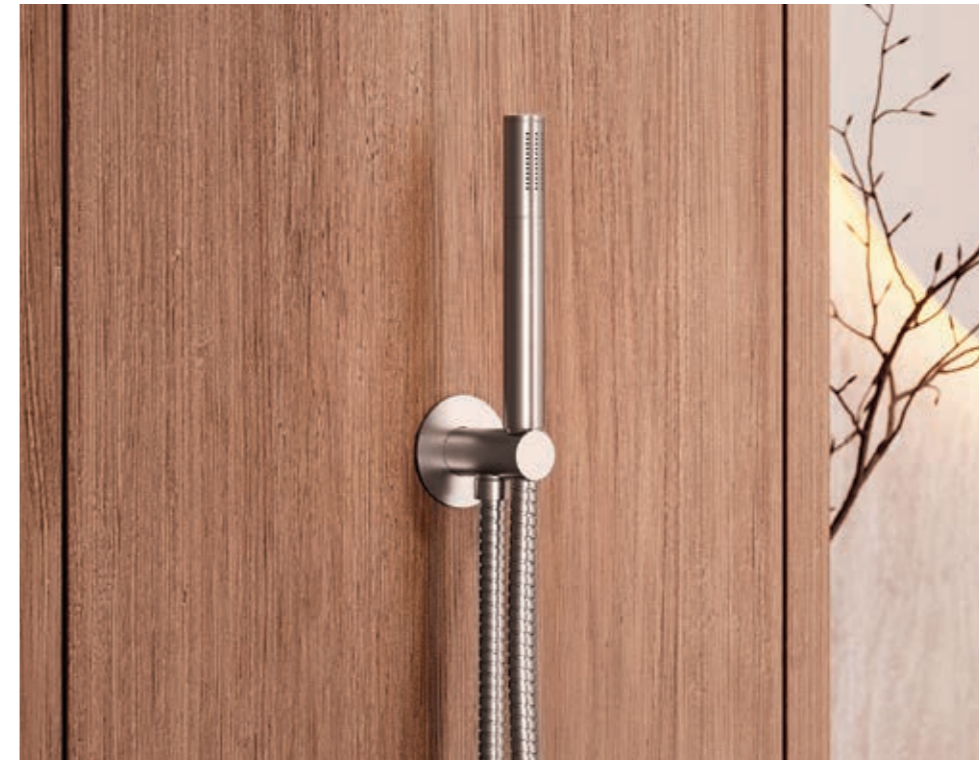

RHE6350



RH03S25

LAVABO
Washbasin

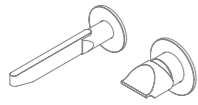

LN-PE-MB-002B

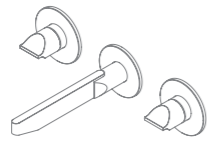

LN-PE-BAC-002B

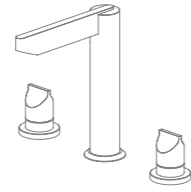

LN010



LN030

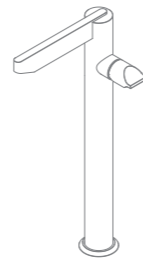

LN050

DOCCIA - TERMOSTATICO
Shower - thermostatic

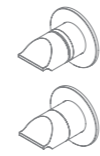

LN-PE-TD2V-002
2-way diverter

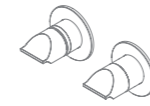

LN-PE-TD2-004
2-way diverter



LN-PE-TAC-001A
1 stop valve

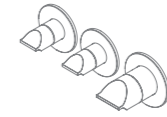

LN-PE-TAC-002B
2 stop valves

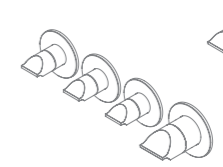

LN-PE-TAC-003C
3 stop valves

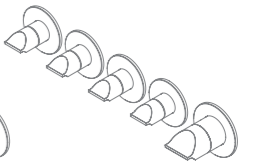

LN-PE-TAC-004D
4 stop valves

LAVABO
Washbasin

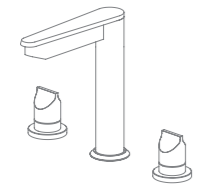

LN010IN

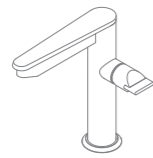

LN030IN

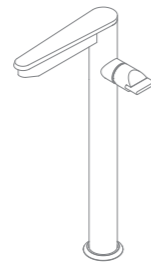

LN050IN



LN070IN



LN070

BIDET
Bidet

DOCCIA - MIXER
Shower - mixer



LN-PE-M-001

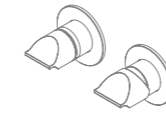

LN-PE-MD2-008
2-way diverter



LN-PE-MD2V-004
2-way diverter

DOCCIA - TERMOSTATICO
Shower - thermostatic

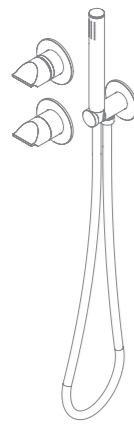

LN-PE-TD2VD-003
2-way diverter

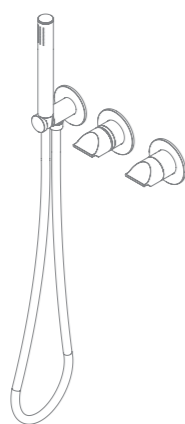

LN-PE-TD2D-001
2-way diverter

DOCCIA - MIXER
Shower - mixer

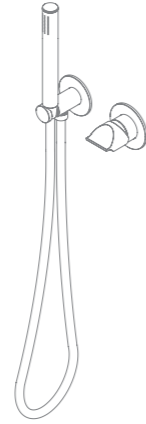

LN-PE-MD-002

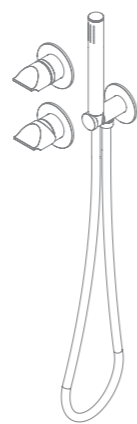

LN-PE-MD2VD-005
2-way diverter

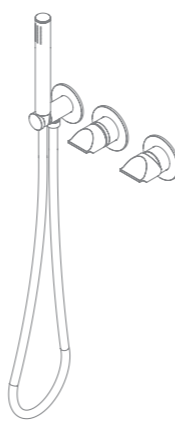

LN-PE-MD2D-003
2-way diverter

VASCA - TERMOSTATICO
Bathtub - thermostatic

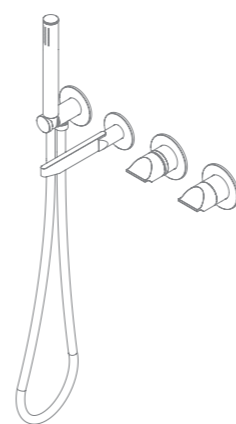

LN-PE-TD2DB-005
2-way diverter

VASCA - MIXER
Bathtub - mixer

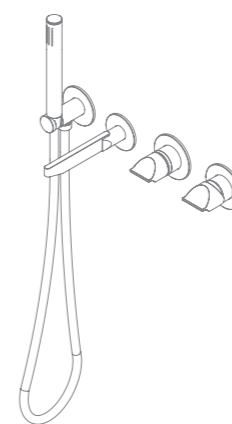

LN-PE-MD2DB-002B
2-way diverter

STELLA

RUBINETTERIA \ TAPS

A refined fusion of volumes, where design and functionality converge in perfect harmony.

UN INCASTRO DI VOLUMI, UNIONE DI DESIGN E PRATICITÀ. \



STELLA



STELLA



STELLA



50

ST0100

STELLA



51

STELLA



STELLA





BIDET
Bidet



ST0070

LAVABO
Washbasin



ST0030



ST0050



ST0090

VASCA
Bathtub



ST0100

COLONNA DOCCIA A MURO
Wall-mounted shower column

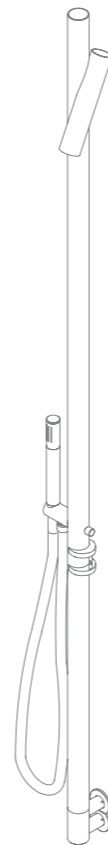

ST6710



ST6610

COLONNE DOCCIA DA TERRA
Floor-standing shower columns

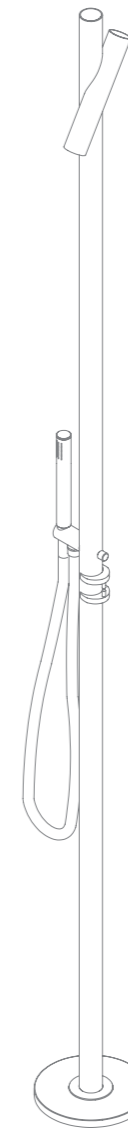

ST6700

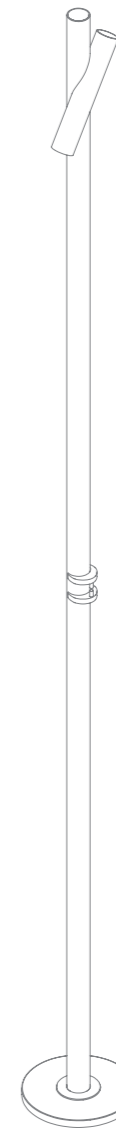

ST6600



ATLASMINIMAL

RUBINETTERIA \ TAPS

57

Extreme minimalism for a bathroom or spa that stands out.

MINIMALISMO ESTREMO
PER UN BAGNO O SPA CHE SI DISTINGUE. \



AM19500

AM3850

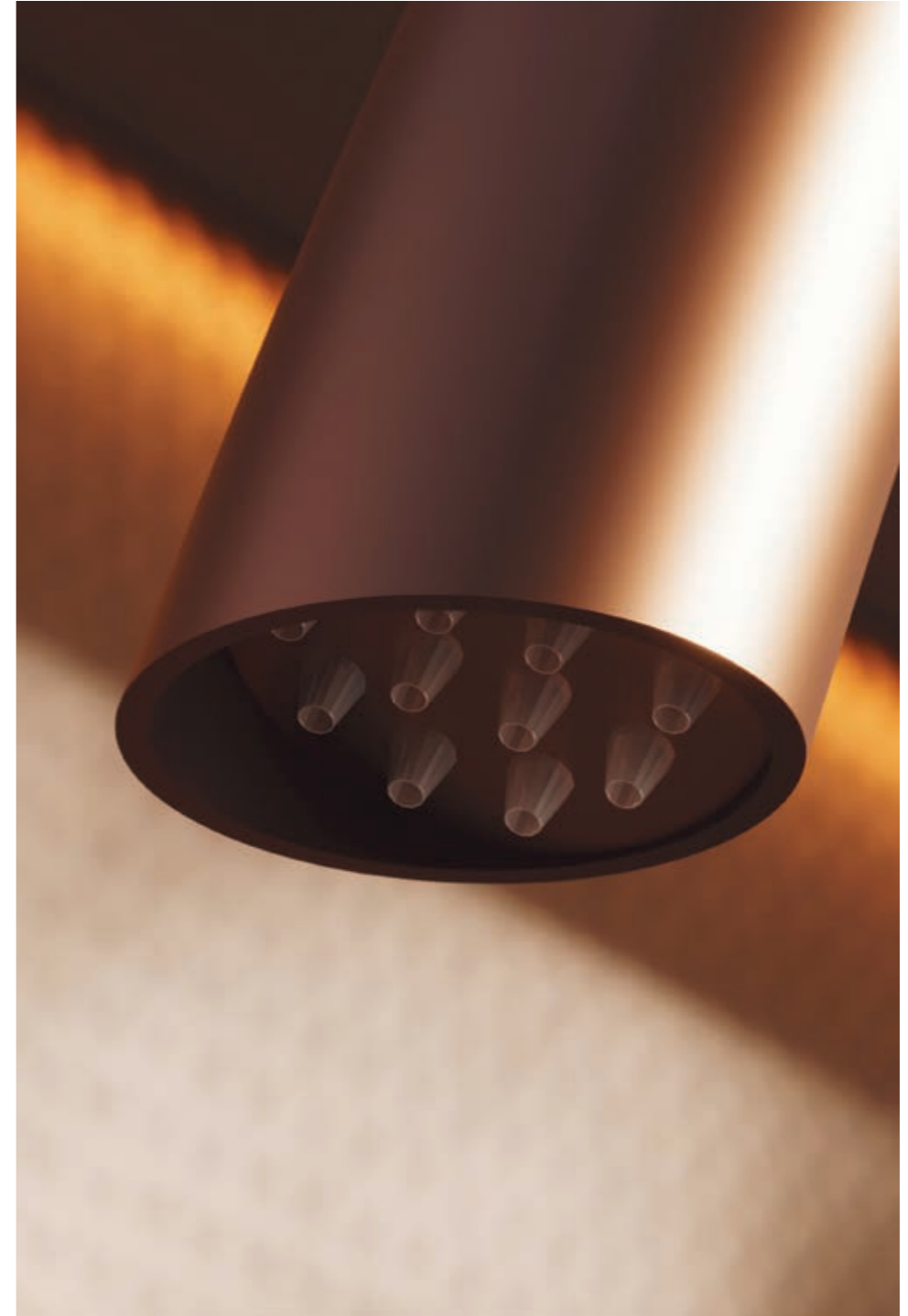
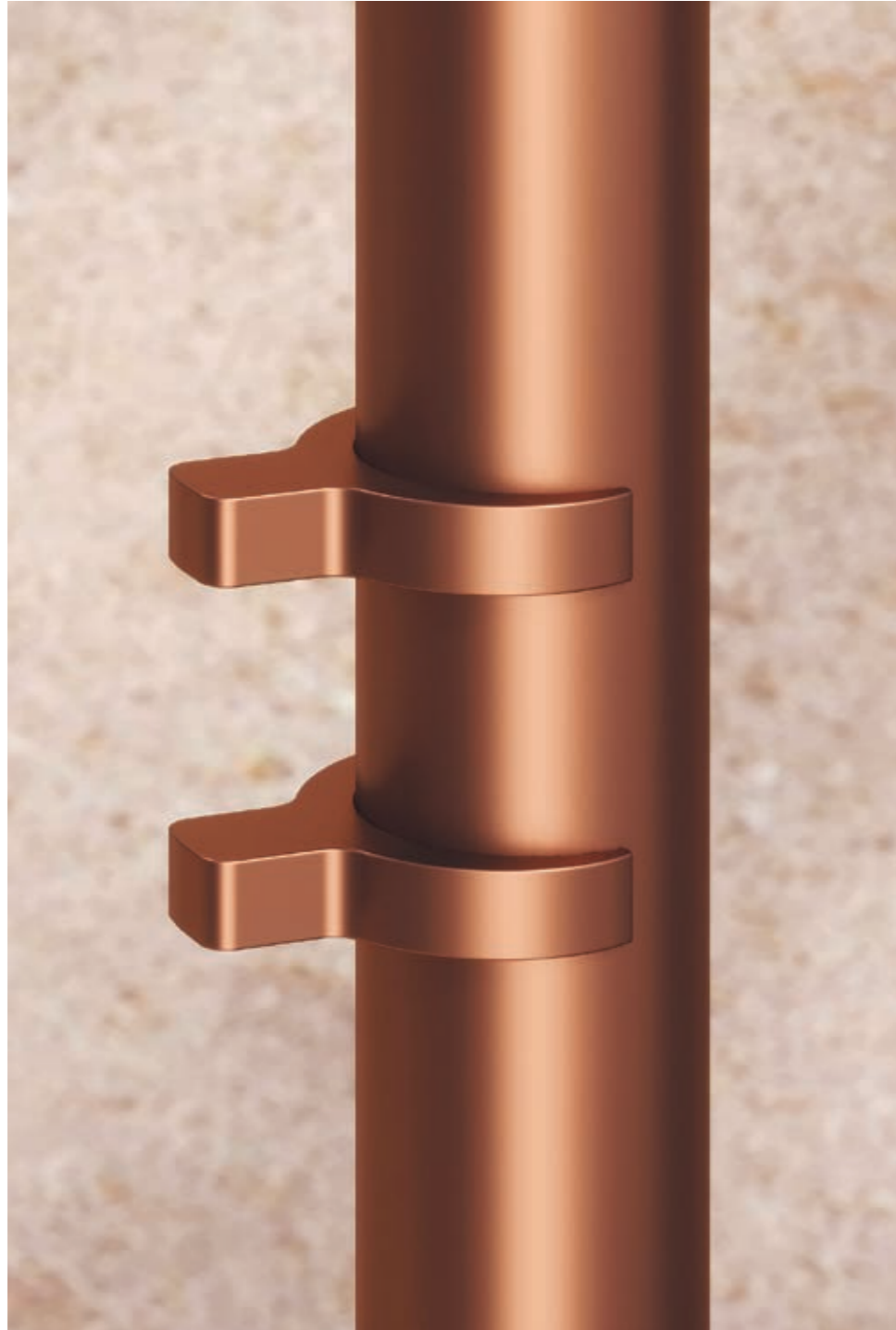

AM3850



AT19500

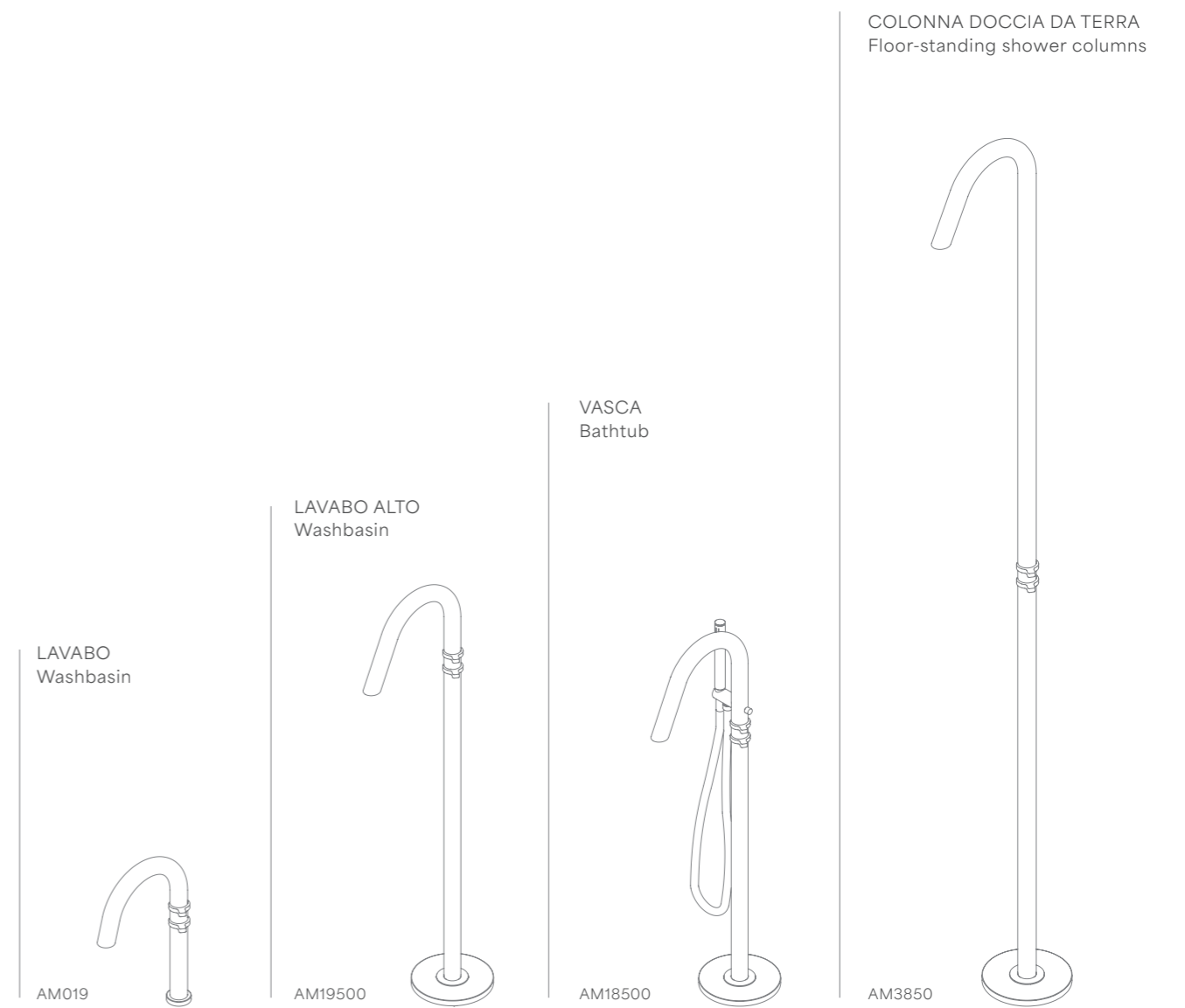

DORIDE

COLONNE DOCCIA \ SHOWER COLUMNS

Classic elegance, reinvented for the contemporary era.

UN CLASSICO SENZA TEMPO RIVISITATO
IN CHIAVE CONTEMPORANEA. \

DORIDE



DORIDE

COLONNE DOCCIA A MURO
Wall-mounted shower column

Nuovo progetto \ New project

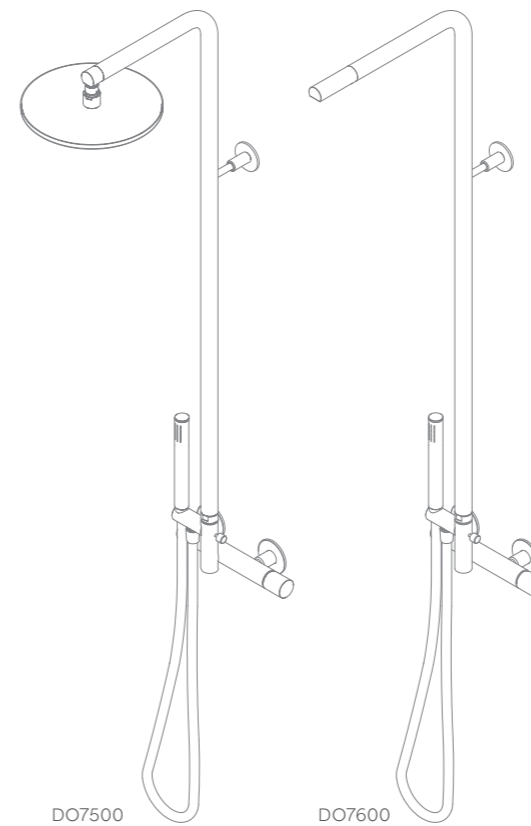

DO7500

DO7600

COLONNE DOCCIA A MURO
Wall-mounted shower column

Ristrutturazione \ Renovation

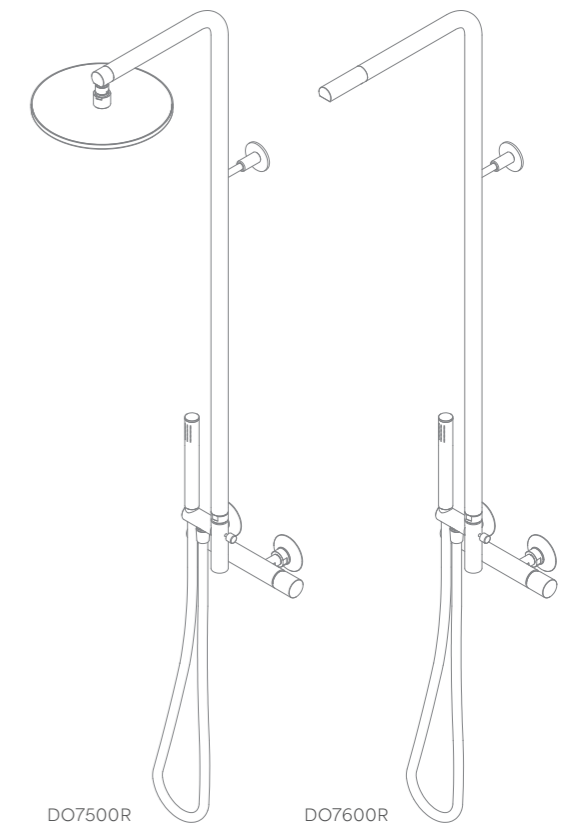

DO7500R

DO7600R

URANO

SOFFIONI E CROMOTERAPIA \ CHROMOTHERAPY AND SHOWER HEADS

Multi-jet harmony, for a deeply immersive experience.

SINFONIA MULTI-GETTO PER UN'ESPERIENZA
SENSORIALE COINVOLGENTE. \

URANO



URANO

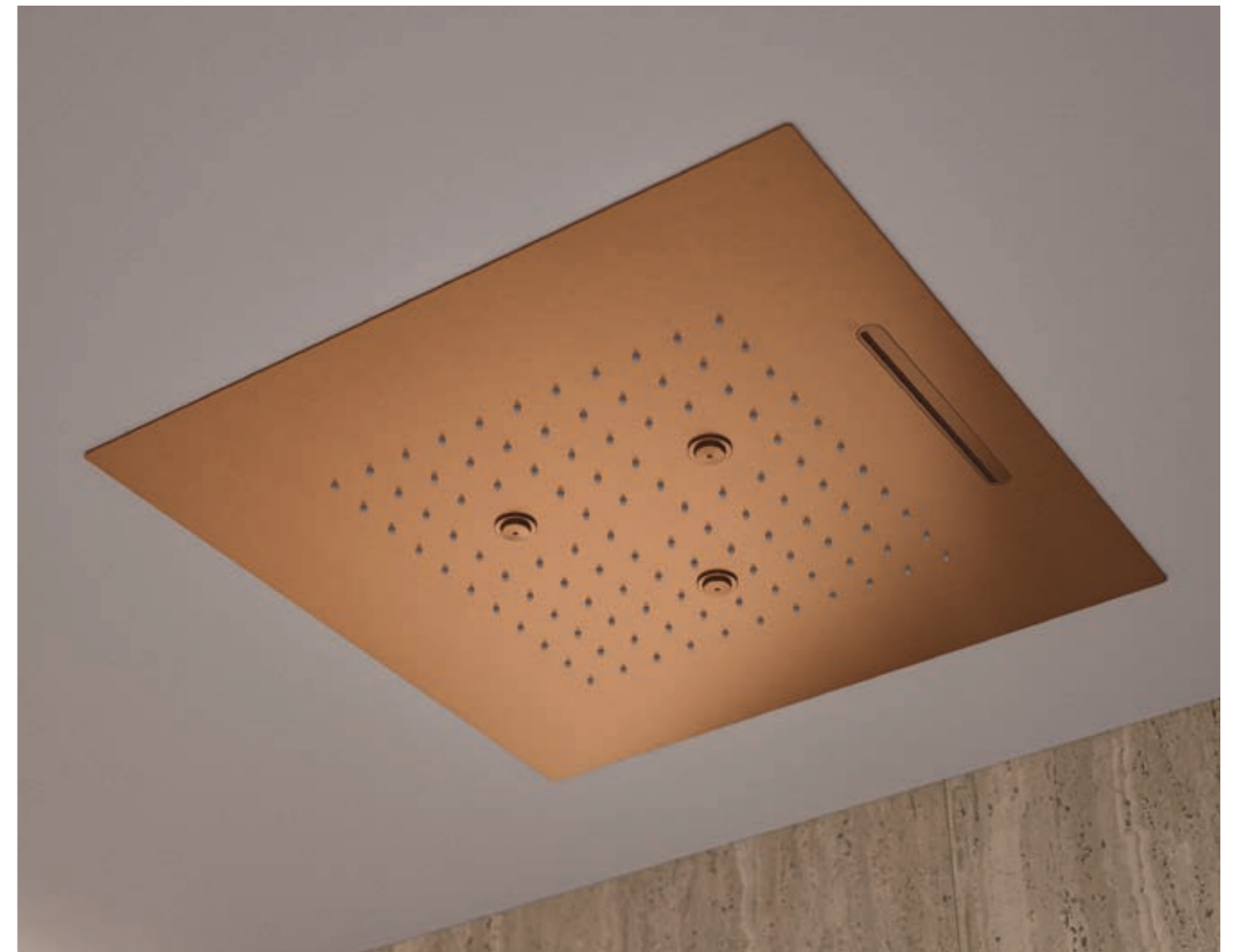

UR9050FNC

SOFFIONI CROMOTERAPIA A INCASSO
Chromotherapy shower heads

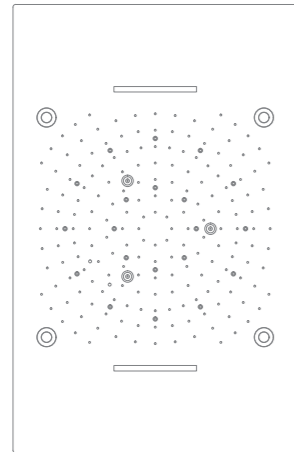

UR9000
4 water jets

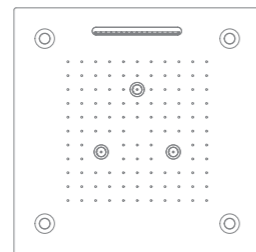

UR9050
3 water jets

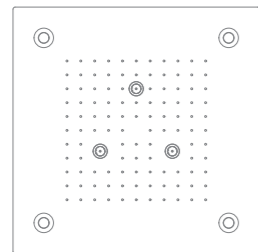

UR9250
2 water jets

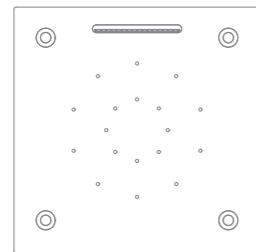

UR9150LT
2 water jets

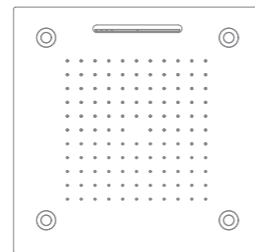

UR9150LF
2 water jets

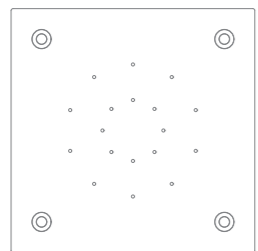

UR9100LT

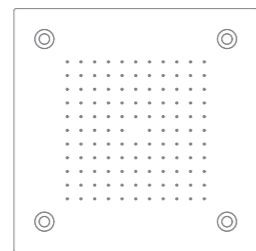

UR9100LF

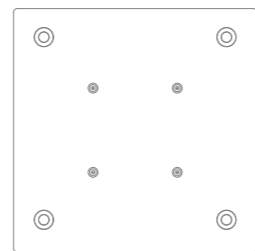

UR9200

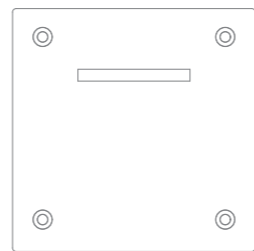

UR9350

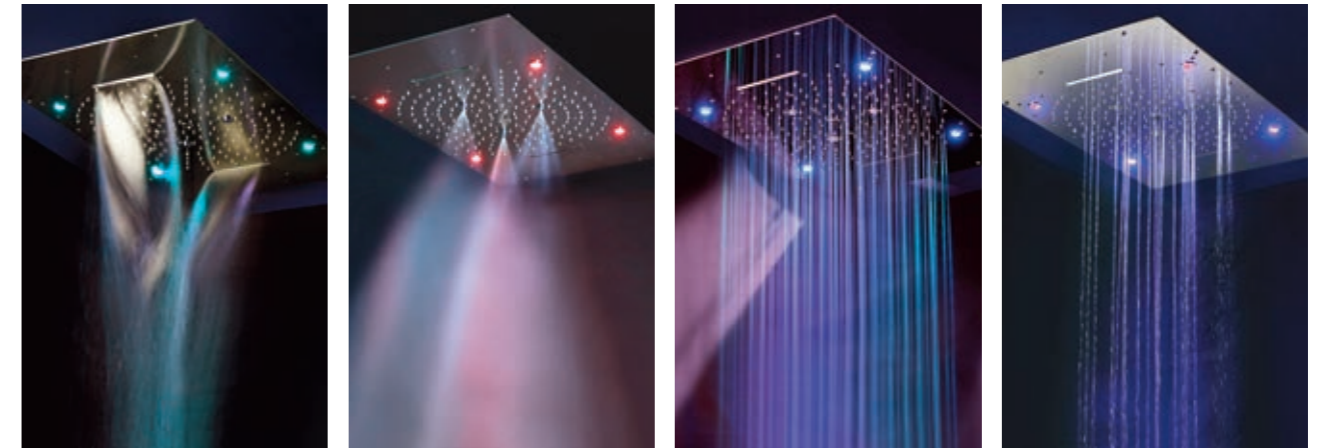

SOFFIONI A INCASSO
Ceiling Shower heads

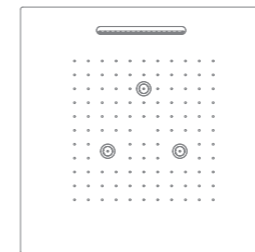

UR9050FNC
3 water jets

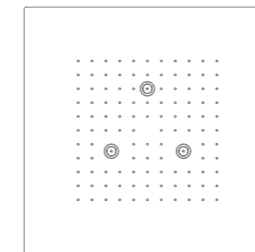

UR9250FN
2 water jets

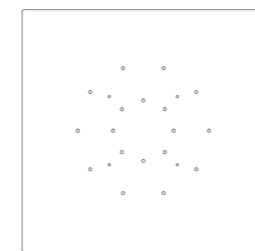

UR9500LT

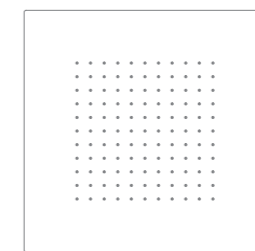

UR9400LF

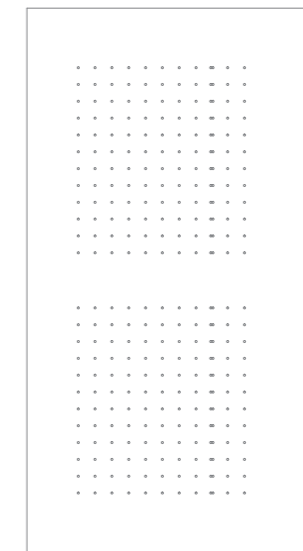

UR9900



SUNRING

SOFFIONI CROMOTERAPIA \ CHROMOTHERAPY SHOWER HEADS

Essential lines that transform light into an enveloping chromotherapy.

LINEA ESSENZIALE PER UNA CROMOTERAPIA IMMERSIVA. \

SUNRING



SUNRING



SR8150



78

SH-PE-MD2D-003

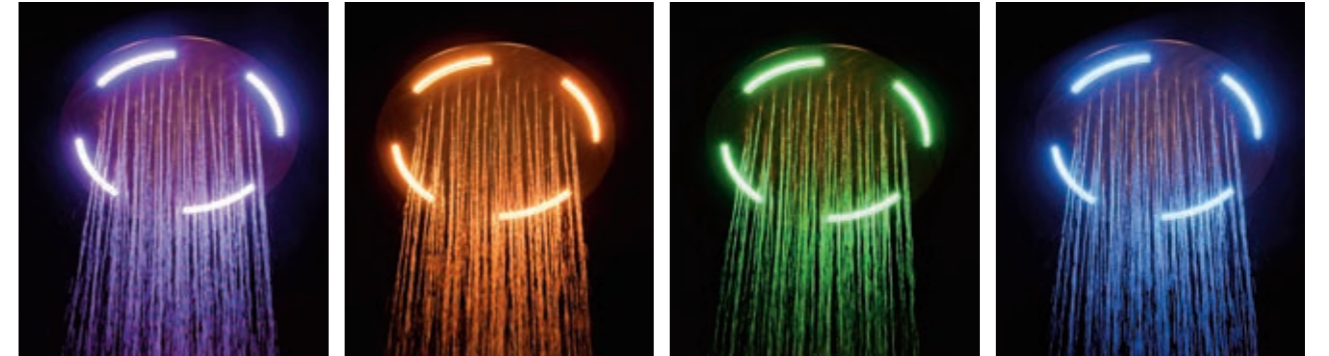

79

SOFFIONI CROMOTERAPIA A INCASSO
Chromotherapy shower heads

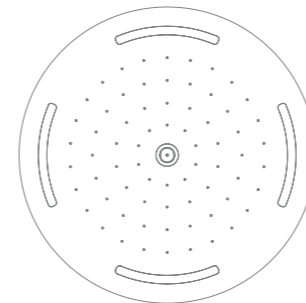

SR8150
2 water jets

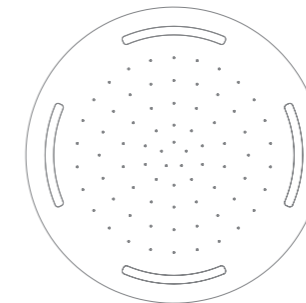

SR8100

PLUVIO

SOFFIONI E CROMOTERAPIA \ CHROMOTHERAPY AND SHOWER HEADS

Wellness and technology, harmoniously designed for a refined home spa.

TECNOLOGIA E BENESSERE PER UNA HOME-SPA ELEGANTE. \

PLUVIO



82

PLUVIO



83

PV9000

SISTEMA DI CONTROLLO
Control Systems



TSUR700



CRUR900EL

SOFFIONI A INCASSO
Ceiling Shower heads

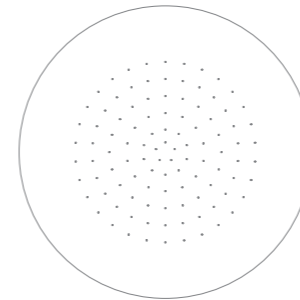

PV9600LF

SOFFIONI CROMOTERAPIA A INCASSO
Chromotherapy shower heads

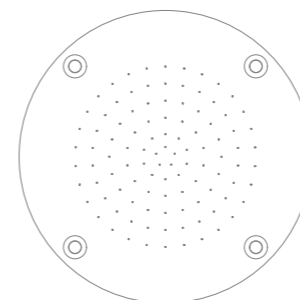

PV9700LF

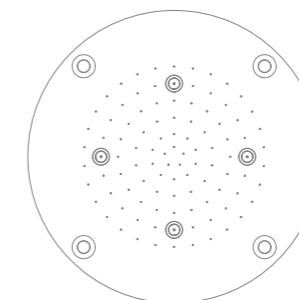

PV9750LN
2 water jets

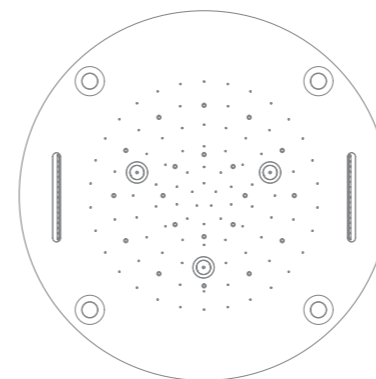

PV9000
4 water jets



RAINYCLOUD

SOFFIONI componibili \ MODULAR SHOWER HEADS

DESIGN BY SIMONE MICHELI

87

Modular wellness for a personalized space.

WELLNESS MODULARE PER UNO SPAZIO PERSONALIZZATO. \

RAINYCLOUD



RAINYCLOUD



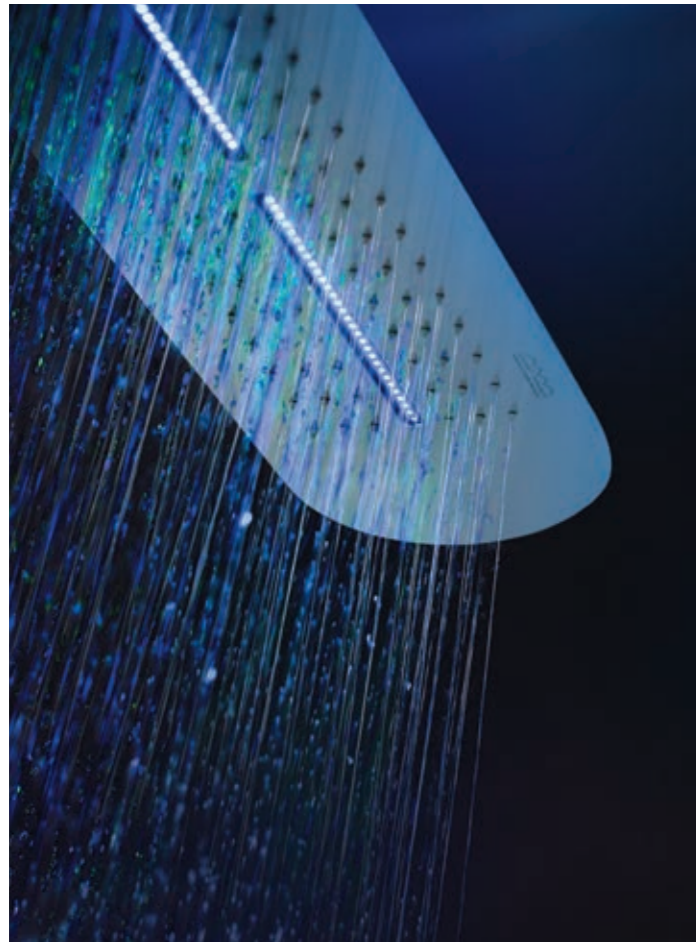

SOFFIONI CROMOTERAPIA A INCASSO COMPONENTI
Modular built-in chromotherapy shower heads

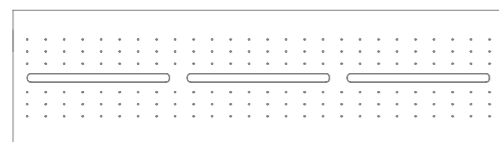

RN1000

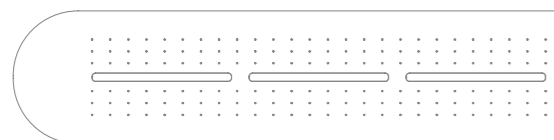

RN2000



RN6000

SOFFIONI CROMOTERAPIA A INCASSO
Chromotherapy shower heads

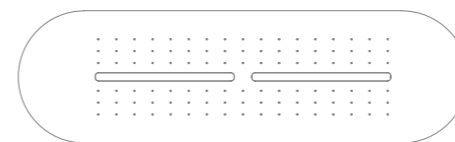

RN3000



RN4000

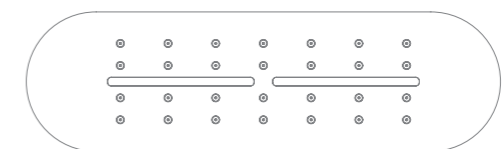

RN5000



ACCESSORI BAGNO

ACCESSORI BAGNO

PORTA ASCIUGAMANO
Towel holder

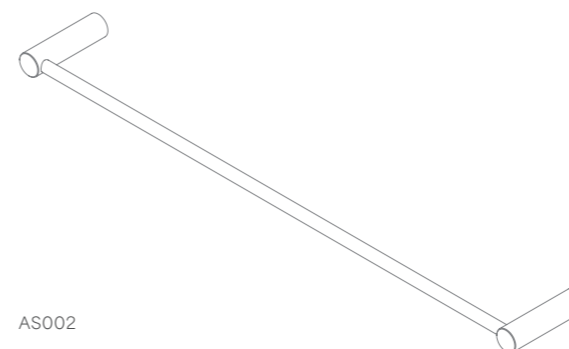

AS002

PORTA ROTOLO
Toilet paper holder

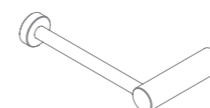

CI003

APPENDIABITI
Hook



SA001



AMA® ITALIA

Via Industriale 51-53
25065 Lumezzane S.S (BS)
Tel +39 030 5231508
info@amals.it

AMA® MEXICO

info@amalsmx.com
+52 33 3836-7713

AMA® USA

info@amaluxuryshower.us
+1 305 564 7887

www.amaluxuryshower.it



Ama Luxury Shower è presente in tutto il mondo. Contattaci per avere informazione sul rivenditore più vicino.
Ama Luxury Shower is present worldwide. Contact us for information on your nearest dealer.

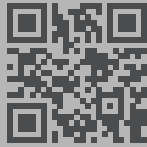

INSIDE316L

